

Clarke®



HOT AIR GUN

MODEL NO: CHG2000C

PART NO: 3400764

USER INSTRUCTIONS



ORIGINAL INSTRUCTIONS

GC0618 ISS 2

INTRODUCTION

Thank you for purchasing this CLARKE Hot Air Gun.

Before attempting to use this product, please read this manual thoroughly and follow the instructions carefully. In doing so you will ensure the safety of yourself and that of others around you, and you can look forward to your purchase giving you long and satisfactory service.

GUARANTEE

This product is guaranteed against faulty manufacture for a period of 12 months from the date of purchase. Please keep your receipt which will be required as proof of purchase.

This guarantee is invalid if the product is found to have been abused or tampered with in any way, or not used for the purpose for which it was intended.





Faulty goods should be returned to their place of purchase, no product can be returned to us without prior permission. This guarantee does not effect your statutory rights.

SPECIFICATION

Dimensions (D x W x H)	250 x 90 x 205 mm
Product Weight	0.74 kg
Operating Voltage/Frequency	230 V - 50 Hz
Input Power	2000 W
Electrical Insulation Class	II
Duty Cycle	Continuous
Temperature Settings: Setting 1: Setting 2:	350°C 550°C
Air Flow Settings: Setting 1: Setting 2:	250 litres/min 550 litres/min

IMPORTANT

Please read all of the safety and operating instructions carefully before using this product. The following safety symbols may be found on the product.

	Read this instruction booklet carefully before use.		Wear protective gloves
	Wear eye protection		Wear dust mask.

GENERAL SAFETY RULES



WARNING: WHEN USING ELECTRIC TOOLS, BASIC SAFETY PRECAUTIONS SHOULD ALWAYS BE FOLLOWED TO REDUCE THE RISK OF FIRE, ELECTRIC SHOCK AND PERSONAL INJURY INCLUDING THE FOLLOWING. READ ALL THESE INSTRUCTIONS BEFORE ATTEMPTING TO OPERATE THIS PRODUCT AND SAVE THESE INSTRUCTIONS FOR FUTURE REFERENCE.

GENERAL SAFETY IN THE WORKPLACE

1. Always keep work area clean & tidy. Cluttered work areas and benches invite accidents.
2. Never over-reach. Keep proper footing and balance at all times.
3. Never store equipment in a wet/damp environment or expose to rain.
4. Always ensure the workplace is well lit. Ensure that lighting is placed so that you will not be working in your own shadow.
5. Keep other persons away. Do not let persons, especially children, not involved in the work, touch the tool or extension cable and keep them away from the work area.
6. Never operate a power tool when under the influence of alcohol, drugs or medication.
7. Stay alert, watch what you are doing, use common sense and do not operate the power tool when you are tired.

CARE OF POWER TOOLS

1. Read this manual carefully. Learn the tool's applications and limitations, as well as the specific potential hazards peculiar to it.
2. Always disconnect the power tool from the power supply before carrying out any repairs or changing of accessories.
3. Do not use a power tool if the switch does not turn it on and off.
4. Always check for any damage or any condition that could affect the operation of the tool. Damaged parts should be properly repaired.
5. This tool complies with the relevant safety standards. Repairs should only be carried out by qualified persons using original spare parts, otherwise this may result in considerable danger to the user.
6. Never use this power tool for any other purpose than that described in these instructions.
7. Never abuse the power cable by yanking the cable to disconnect it from the socket. Keep the cable away from heat, oil or sharp edges.
8. Guard against electric shock. Avoid body contact with earthed or grounded surfaces.
9. If the tool should be used outdoors, use only extension cables intended for outdoor use and marked accordingly.
10. Avoid accidental starting by making sure the power switch is off before plugging in the power cable.

ADDITIONAL SAFETY RULES FOR HOT AIR GUNS



CAUTION: WITH ALL TOOLS, THERE ARE CERTAIN HAZARDS INVOLVED WITH THEIR OPERATION AND USE. EXERCISING RESPECT AND CAUTION WILL CONSIDERABLY LESSEN THE RISK OF PERSONAL INJURY. HOWEVER, IF NORMAL SAFETY PRECAUTIONS ARE OVERLOOKED, OR IGNORED, PERSONAL INJURY TO THE OPERATOR, OR DAMAGE TO PROPERTY MAY RESULT.

1. Always keep the mains cable well away from the hot air gun, particularly if laying it down temporarily during use.
2. Never leave the hot air gun unattended when it is switched on.
3. Always wear safety gloves and never touch the hot nozzle.
4. Never point the hot air gun at any person or animal.
5. Never use in an atmosphere where solvent vapours are present.
6. Never use the hot air gun as a hair dryer.

7. Be aware that heat generated by the hot air gun could cause nearby materials to ignite - particularly in confined spaces. Take all necessary precautions - have a fire extinguisher or means to extinguish a fire to hand.
8. Be aware that fumes given off by paint could be toxic. Take all necessary precautions - consult paint manufacturer etc where necessary.
9. Do not stand on a soft surface. The air gun could topple over or the air intakes become blocked.
10. Always ensure that air can circulate around the hot air gun and that the air vents are unobstructed.
11. Be aware that heat may be conducted to combustible materials that are out of sight. Do not apply heat to the same place for a long time.
12. Always switch the hot air gun OFF after use and stand it upright while it cools. Place the gun where it cannot cause damage or be accidentally touched by persons in the area.

ENVIRONMENTAL RECYCLING POLICY



Through purchase of this product, the customer is taking on the obligation to deal with the WEEE in accordance with the WEEE regulations in relation to the treatment, recycling & recovery and environmentally sound disposal of the WEEE.

In effect, this means that this product must not be disposed of with general household waste. It must be disposed of according to the laws governing Waste Electrical and Electronic Equipment (WEEE) at a recognised disposal facility.

ELECTRICAL CONNECTIONS



WARNING! READ THESE ELECTRICAL SAFETY INSTRUCTIONS THOROUGHLY BEFORE CONNECTING THE PRODUCT TO THE MAINS SUPPLY.

Before switching the product on, make sure that the voltage of your electricity supply is the same as that indicated on the rating plate. This product is designed to operate on 230VAC 50Hz. Connecting it to any other power source may cause damage.

This product may be fitted with a non-rewireable plug. If it is necessary to change the fuse in the plug, the fuse cover must be refitted. If the fuse cover becomes lost or damaged, the plug must not be used until a suitable replacement is obtained.

If the plug has to be changed because it is not suitable for your socket, or due to damage, it should be cut off and a replacement fitted, following the wiring instructions shown below. The old plug must be disposed of safely, as insertion into a mains socket could cause an electrical hazard.



**WARNING! THE WIRES IN THE POWER CABLE OF THIS PRODUCT ARE COLOURED IN ACCORDANCE WITH THE FOLLOWING CODE:
Blue = Neutral Brown = Live**

If the colours of the wires in the power cable of this product do not correspond with the markings on the terminals of your plug, proceed as follows.

- The wire which is coloured **Blue** must be connected to the terminal which is marked **N** or coloured **Black**.
- The wire which is coloured **Brown** must be connected to the terminal which is marked **L** or coloured **Red**.

Plug must be BS1363/A approved.

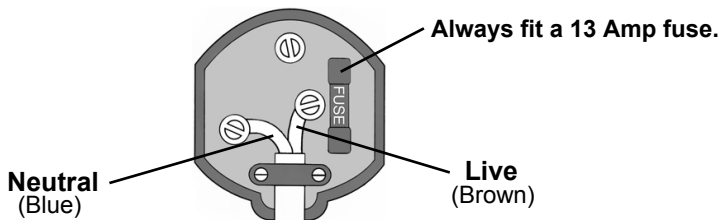

Ensure that the outer sheath of the cable is firmly held by the clamp

We strongly recommend that this machine is connected to the mains supply via a Residual Current Device (RCD)

If in any doubt, consult a qualified electrician. DO NOT attempt any repairs yourself.



This symbol indicates that this is a Class II product, and does not require an earth connection.

PRODUCT OVERVIEW



NO	DESCRIPTION	NO	DESCRIPTION
1	Handle for Triangular Shave Hook	5	Concentrator Nozzle
2	Moulded Plastic Carry Case	6	Glass Protection Nozzle
3	Hot Air Gun	7	Reflector Nozzle
4	Triangular Shavehook (scraper)	8	Diffuser Nozzle

INVENTORY CHECK

Before starting work, please check contents against the list above and advise your dealer immediately if any parts are missing.

OPERATION

Before starting work it is recommended that you heat a test piece to ensure you have the correct heat setting. In addition you should always take steps to protect sensitive or delicate areas where the effect of heat could cause damage (i.e. glass and plastics). Do not apply heat to the same place for a long time.

After the work has been completed, switch the gun off, disconnect from the mains supply and allow to cool in a safe place.

Take care not to drop the gun as this could damage the heating element.

To prevent the gun from overheating, maintain a minimum distance of 3 cm between the end of the nozzle and the work piece.

REMOVING PAINT AND DISSOLVING ADHESIVES

1. Fit the nozzle to the front of the gun.
2. With the switch in the '0' (OFF) position plug the gun into the mains supply.
3. Set the switch to either position 1 or 2 according to how much heat is required. (see Specification).
 - Ensure the nozzle is pointing away from you.
4. Bring the nozzle of the hot air gun to the work piece approximately 3 cm from the surface.
 - The exact distance between the nozzle and the work piece will be dependent on the material being worked on.
 - Paint will rapidly become soft and blister, at which point it can be removed with the triangular shave hook. Do not allow paint to burn as this will make the removal process more difficult.
 - Most adhesives dissolve when heated and these can then be removed, taking care that any parts from which glue is removed are heat resistant.
 - Heating and paint removal are performed simultaneously, with the shave hook following the hot air gun.
5. Clean the shavehook blade quickly if paint/glue becomes stuck to it.
 - Profiled parts may be cleaned with a suitable wire brush once paint is softened.



- Normally only one pass is required to remove both thick and thin layers of paint.

REMOVING PAINT FROM WINDOW FRAMES

DO NOT point the gun directly at glass and always ensure it is adequately protected. A glass protection nozzle is provided for use when stripping window frames etc.

1. Fit the glass protection nozzle to the front of the hot air gun and angle it so that the gun can be placed up against the window, with the cowl of the nozzle, flat against the glass as shown.
2. It will be necessary to change the position of the protection nozzle as you work around the window pane. Ensure you wear adequate hand protection when doing so.
3. The protection nozzle must be kept in contact with the work at all times, but do not spend too much time in one area.

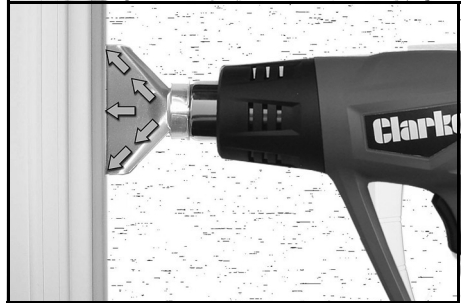

FORMING AND WELDING PLASTIC PARTS

When bending or forming plastic parts, work slowly and with great care observing the effects of heat on such materials.

NOTE: With plastics, the temperature range between solid, pliable and liquid states is narrow, therefore great care should be taken.

WOOD STAINING

Wood can be stained giving a 'rustic' effect.

1. Fit the diffuser nozzle to the front of the hot air gun.
2. Do not hold the nozzle too close to the wood as this may cause the wood to colour unevenly.
3. Use a fine sandpaper to remove any singed wood fibres when finished.

HEAT SHRINK SLEEVE FITTING

Fit the concentrating nozzle to the front of the hot air gun.

1. Select a suitable size heat shrink sleeve for the work piece.
2. Heat the sleeve evenly.

THAWING WATER PIPES



Fit the reflector nozzle to the front of the hot air gun.

1. Always heat frozen areas inwards from the edge to the centre.
2. Take special care when defrosting plastic pipes.
3. Provide protection against heat damage to nearby paint and wall coverings where necessary.
4. Be aware that copper gas pipes can be difficult to distinguish from copper water pipes. Always check first.
5. Copper pipes are soldered together, therefore should not be heated above 200°C.

MAINTENANCE

This hot air gun is maintenance free, except always ensure that the air intake vents are kept clean. If used in a dusty environment clean the tool with low pressure compressed air.

DECLARATION OF CONFORMITY

	 Hemmill Street, Epping, Essex, CM16 4JG	DECLARATION OF CONFORMITY	
		This is an important document and should be retained.	
We hereby declare that this product(s) complies with the following directive(s):			
2014/53/EU	Electromagnetic Compatibility Directive.		
2014/35/EU	Low Voltage Equipment Directive.		
2011/65/EU	Restriction of Hazardous substances.		
The following standards have been applied to the product(s):			
EN 55014-1:2006+A1+A2	EN 55014-2:2015	EN 61000-3-2:2014	EN 61000-3-3:2013
EN 60335-1:2012+A11	EN 62233:2006	EN 60335-2-45:2002+A1+A2	
The technical documentation required to demonstrate that the product(s) meet(s) the requirement(s) of the aforementioned directive(s) has been compiled and is available for inspection by the relevant enforcement authorities.		The CE mark was first applied in: 2018	
Product Description:	2000W, 1600W Hot Air Guns		
Model number(s):	CHG 2000C, CHG1600		
Serial / batch Number:	N/A		
Date of Issue:	25/06/2018		
Signed:		J.A. Clarke	Director
			Page 1 of 1
			CHG2000C/CHG 1600 Hot air gun IDOC R V1

COMPONENT PARTS AND MAINTENANCE

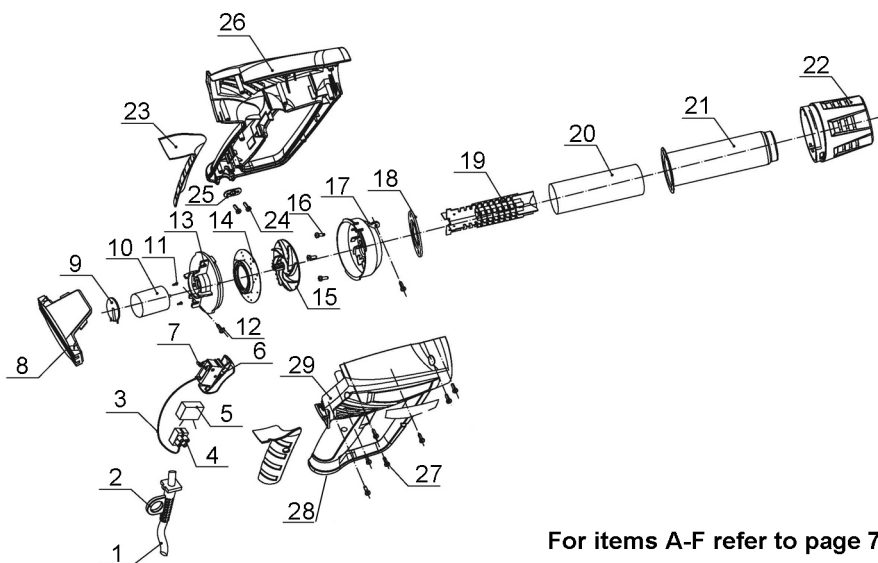

For items A-F refer to page 7.

1	Power Cable	18	Insulator
2	Cable Sleeve	19	Heating Element Assembly
3	Connecting Wire	20	Mica Sleeve
4	Terminal Capacitor	21	Tube
5	Capacitor 0.47uF	22	Front Cover
6	Switch	23	Handle Grip
7	Diode	24	Screw ST3x14
8	Rear Enclosure	25	Cable Clamp
9	Rectifier	26	Housing - Lefthand
10	Motor	27	Screw ST3x16
11	Screw M2.5x4	28	Housing - Righthand
12	Screw st3x13	A	Concentrator Nozzle
13	Motor Support	B	Diffuser Nozzle
14	Fan Backplate	C	Glass Protector Nozzle
15	Fan	D	Reflector for Nozzle
16	Screw ST3x10	E	Triangular Shave Hook
17	Fan Cover	F	Triangular Shave Hook Handle

A SELECTION FROM THE VAST RANGE OF

Clarke®

QUALITY PRODUCTS

AIR COMPRESSORS

From DIY to industrial, Plus air tools, spray guns and accessories.

GENERATORS

Prime duty or emergency standby for business, home and leisure.

POWER WASHERS

Hot and cold, electric and engine driven - we have what you need

WELDERS

Mig, Arc, Tig and Spot. From DIY to auto/industrial.

METALWORKING

Drills, grinders and saws for DIY and professional use.

WOODWORKING

Saws, sanders, lathes, mortisers and dust extraction.

HYDRAULICS

Cranes, body repair kits, transmission jacks for all types of workshop use.

WATER PUMPS

Submersible, electric and engine driven for DIY, agriculture and industry.

POWERTOOLS

Angle grinders, cordless drill sets, saws and sanders.

STARTERS/CHARGERS

All sizes for car and commercial use.



PARTS & SERVICE: 0208 988 7400

E-mail: Parts@clarkeinternational.com or Service@clarkeinternational.com

SALES: UK 01992 565333 or Export 00 44 (0)1992 565335

Clarke® INTERNATIONAL Hemnall Street, Epping, Essex CM16 4LG
www.clarkeinternational.com